

NETWORK ANALYSIS

EE, ECE, EEE, IN Engineering

Theory & Objective

*By
Team of
Engineers Academy*

- Covers ESE, GATE, IAS, PSUs, DRDO, ISRO & other Technical Exams.
- Covers complete syllabus & all topics of ESE & GATE examination.
- Thoroughly revised, fully solved & error free book.
- Concise, concept oriented and topicwise presentation & authentic solutions.



ENGINEERS ACADEMYTM

Your GATEway to Professional Excellence

IES • GATE • PSUs • JTO • IAS • NET

Corporate Office : 100-102, Ram Nagar, Bambala Puliya, Pratap Nagar, Jaipur-302033

Ph. : 0141-6540911, +91-8094441999

Head Office : 40-Kailashpuri, Near Khandaka Hospital, Gopalpura, Tonk Road, Jaipur-302018

Ph. : 0141-6540910, +91-8094441777

Website : www.engineersacademy.org | **Email:** info@engineersacademy.org

ESE

GATE

JEn

JTO

TTA

PSU

अतुल्य | EA

*Again we proved
"We are history maker"*

GATE-2016



2
AIR **AVINASH SHAH**
EA Roll No. : IN102/2015-16

2
AIR **ABHAMANU JAIN**
RPSC : AEn



RRB-JEn & SSC-JEn
Parimal Meghwal (EE)
Roll No. : 11429402018371
Post : Junior Engineer (Ahmedabad)

Ramavtar Meena
Roll No. : 13NBC15106129
Branch : Civil, NBCC
Post : Junior Engineer

GATE-2016 : TOPPERS

many results are awaited...

ESE TOPPERS

JTO & TTA TOPPERS

AEn & JEn TOPPERS

स्वायत्त शासन विभाग राज. सरकार (राजस्थान नगर पालिका)

सहायक अभियंता

Roll No. : 21414346670 Civil : Assistant Engineer	Roll No. : 22046373468 Civil : Assistant Engineer	Roll No. : 11630363603 Civil : Assistant Engineer	Roll No. : 31452341723 Civil : Assistant Engineer

WRD : 2016 Selection



ENGINEERS ACADEMYTM

Your GATEway to Professional Excellence

IES • GATE • PSUs • JTO • IAS • NET

Ph. : 0141-6540910, +91-8094441777 / 999

Website : www.engineersacademy.org | Email: info@engineersacademy.org

Ahmedabad | Allahabad | Ajmer | Bhilwara | Jalandhar | Jodhpur | Kota | LPU Campus | Lucknow | Ludhiana | Patna | Jaipur

CONTENTS

S.No.	TOPIC	Page No.
1.	Basics of Circuit Element and Circuit Law	01 – 56
2.	Network Theorems	57 – 114
3.	Transient Response	115 – 194
4.	Laplace Transform	195 – 208
5.	Two Port Networks	209 – 240
6.	Magnetically Coupled Circuits	241 – 254
7.	AC Circuits and Resonance	255 – 303
8.	Graph Theory	304 – 320
9.	Network Functions	331 – 336
10.	Network Synthesis	337 – 352
11.	Filters	353 – 363
12.	Three Phase Circuits	364 – 374



ENGINEERS ACADEMY
PUBLICATIONS

Log on to : www.eapublications.org | Ph. : 08094441777

Visit us:
www.engineersacademy.org

WhatsApp :
+91-8094441777

engineersacademyindia.blogspot.in



Facebook :
Engineersacademy.org

SMS :
+91-8094441999

AcademymyIndia

Institute for ESE • GATE • PSUs • JEn • JTO & TTA

ESE : TOPPER



Deepika Gill
AIR-5 (CE)



Atesh Kumar
AIR-12 : EC



Lavesh Pupta
AIR-12 : EE



Sushant Parashar
AIR-16 (EE)



Naveen Joshi
AIR-17 : EC



Rohit Mahes.
AIR-19 : CE



Pawan
AIR 22 (EE)



Ran Singh
AIR - 22 (ECE)



Sanapala Abhiram
AIR-23 (CE)



Sandeep Dhaked
AIR-31(ECE)



Saurabh
AIR-31 : ME



Yoges
AIR-33 : EE



Abhishek
AIR-37 (ME)



Neelanshee
AIR-38 : EE



Sheetanshu Tiwari
AIR-47 (EE)



Aditya Amber
AIR-46 : EC



Gaurav Jasuja
AIR-52 : EE



Neha Mehta
AIR-53 : CE



Saurabh Singh
AIR-56 : CE



Devi Shankar
AIR-57 : ME



Krishan
AIR-63 (ME)



Pramod Dudi
AIR-67 : ME



Prashank
AIR-69 (EE)



Neelu Sreekumar
AIR-72 (ECE)



Narain Pratap
AIR-73 : CE



Ravi Kumar
AIR-76 : CE



Anuj Kushari
AIR-78 : CE



Upkar Pathak
AIR-81 (CE)



Shri Krishan
AIR-87 : ME



Sandeep
AIR-94 : EC



Rampakar Raman
AIR-94 : ME



Prince Bhati
AIR-111 : ME



Bhaskar
AIR-120 : ME



Kalindi
AIR-122 : ME



Meer Singh
AIR-127 : EE



PSUs : TOPPER



Raj Kumar (Branch : EE)
SSC-JEn, RRB-SSE
1st Rank: Odonil Factory



Himanshu Bhaskar
Branch : CE
NITIE-Bombay



Shreyansh Dhankhar
Branch : CS & IT
IISc, Bangalore



Ranjeet Kumar Gupta
Branch : ME
IOCL



Prakash Kumawat
Branch : EE
BEL



Shyam Sundar Pareek
Branch : EE
BEL



Vishal Sharma
Branch : ME
JINDAL SAW Ltd.



Ankit Gupta
Branch : EE
HPCL, THDC



Dharmanshu Mittal
Branch : ME
BARC



Pavan Kumar Nagar
Branch : CE
BARC



Swarupa
HPCL



Alok Kumar
Branch : EE (HAL)



Ajeet Vagle
Branch : EE(NTPC)



Prachi Adity
BHEL



Paras Bareja
Branch : EE(IOCL)



Smita Gupta
Branch : AAI



Ratan Kumar
NTPC



Kuldeep
BSNL-JTO

Admission Open for ESE, GATE, PSUs, JEn, JTO, TTA & Other Technical Competitive Exam

ENGINEERS ACADEMY

Your GATEway to Professional Excellence

IES • GATE • PSUs • JTO • IAS • NET

Corporate Office :

100-102, Ram Nagar, Bambala Puliya,
Pratap Nagar, Jaipur

Head Office :

40-Kailashpuri, Near Khandaka Hospital,
Gopalpura, Tonk Road, Jaipur

ALLAHABAD
(+91-7376760666)

AHMEDABAD
(+91-9727776565)

AJMER
(+91-7737278888)

BHILWARA
(+91-9351770644)

JALANDHAR
(+91-7589441777)

JAIPUR
(+91-8094441999)

JODHPUR
(+91-9928665551)

KOTA
(+91-8290256342)

LPU CAMPUS
(+91-9465220033)

LUDHIANA
(+91-9888928477)

LUCKNOW
(+91-7080555455)

PATNA
(+91-8434441777)

SIKAR
(+91-8094401333)

Every Thing in This World is Directly or Indirectly Related to Engineering



BASICS OF CIRCUIT ELEMENT AND CIRCUIT LAW

THEORY

1.1 CIRCUIT ELEMENT

Circuit element is a part of an electric circuit or network.

One of the three quantitative attributes (resistance, inductance, capacitance) characteristic of an electric circuit.

1.2 CLASSIFICATION OF ELEMENTS

- (i) Active and passive element
- (ii) Unidirectional and bidirectional
- (iii) Linear and non-linear element
- (iv) Lumped and distributed element
- (v) Time variant and time invariant element

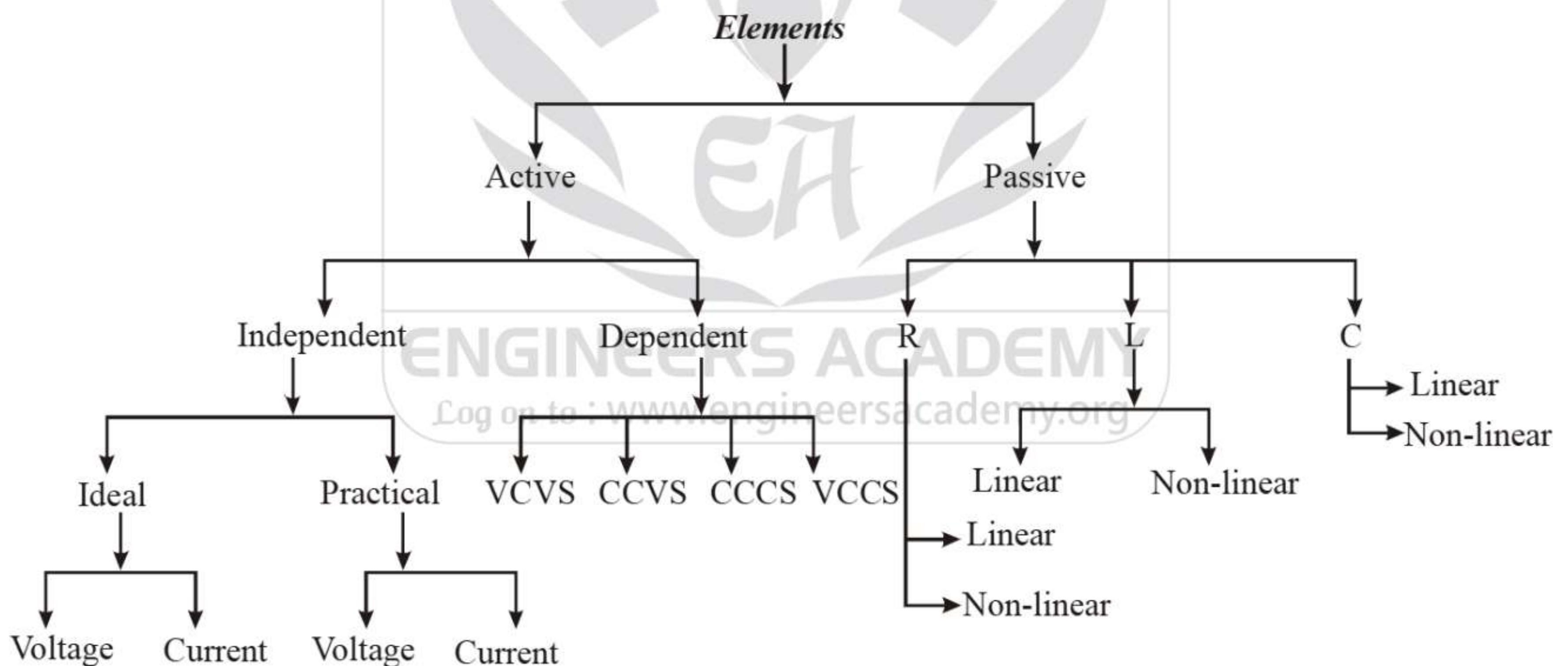

1.2.1 ACTIVE ELEMENT AND PASSIVE ELEMENT

ACTIVE ELEMENT

When the element is capable of delivering energy independently for long time (approximately ∞) or when the element is having property of internal amplification. Then the element is called as active element. It does not require external source of energy.

Example: Voltage and current source are independent source. Transistor and op-amp are dependent source.



PASSIVE ELEMENT

When element can not deliver energy independently, the element is called as passive element.

It requires external source of energy.

(i) Resistance

- It is property of material
- It opposes the flow of charge carrier (e^-)
- It converts electrical energy to heat energy
- It's unit is ohm (Ω) & indicated by R.
- Resistance depends upon temperature

$$R_t = R_0 (1 + \alpha_0 T) \quad \dots(1)$$

Where,

R_0 = Material Resistance at 0°C

α_0 = Temperature coefficient

T = Temperature

The symbolic representation is



Ohm's law : It states that current density (J) is directly proportional to electric field intensity (E).

$$J \propto E$$

$$J = \sigma E$$

$$J = \frac{I}{A} = \frac{1}{\rho} \frac{V}{l}$$

$$\frac{V}{I} = \frac{\rho l}{A}$$

$$\frac{V}{I} = \frac{\rho l}{A} = R = \text{Constant}$$

$$V = RI$$

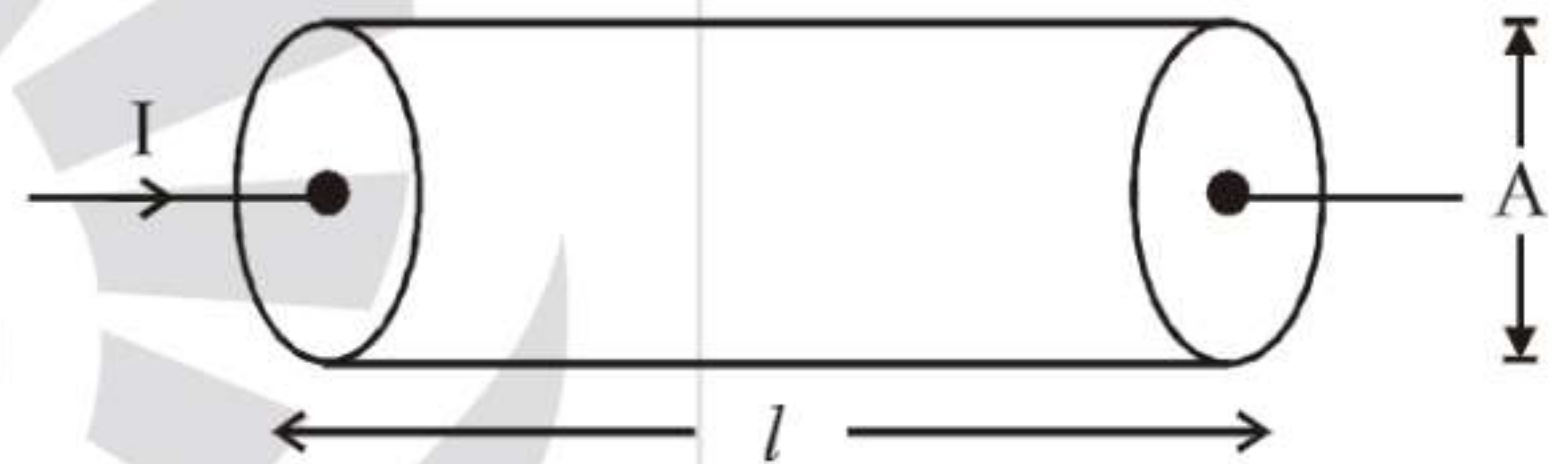

- It state that potential difference across the element is directly proportional to current flowing through element.
 - It is valid when temperature and conductivity of material are constant.
- Ohm's law may be written in several ways.

$$J = \sigma E \quad (\text{First form})$$

Where

σ = Conductivity and its unit is $\Omega^{-1} \text{ m}^{-1}$.

$$V = RI \quad (\text{Second form})$$

$$I = GV \quad (\text{Third form})$$

Where

G = Conductance and its unit is siemens Ω^{-1} .

$$V = R \frac{dQ}{dt} \quad (\text{Fourth form})$$

Where

Q = Charge and its unit is Coulomb (C).

- Ohm's law is applicable for any "bilateral conductor".
- If value of R is negative, then this will act as an active element but practically, this is not possible.



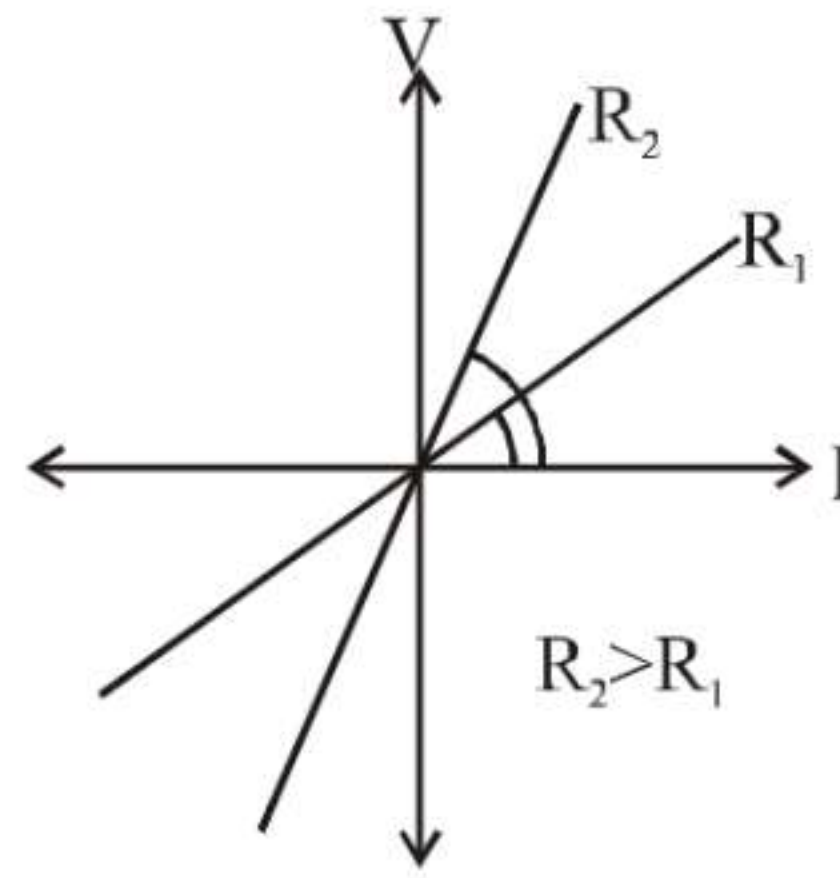

(ii) **Inductance :**

It opposes rate of change of magnitude and direction of electric current passing through it.

It is indicated by L and unit is Henry.

The symbolic representation is



Faraday first law states that when conductor cuts a magnetic lines of force, an emf is induced in conductor.

Faraday second law states that emf induced in conductor is directly proportional to rate of change of flux (ϕ).

Note : Flux is the presence of a force field in a specified physical medium.

$$e \propto \frac{d\phi}{dt}$$

Where,

e = Dynamic induced emf

ϕ = Flux

$$e = -N \frac{d\phi}{dt}$$

This is Lenz's Law.

An inductor is a passive electronic component that store energy in the form of magnetic field.

Simplest form of inductor is wire loop or coil.

The inductance is directly proportional to the number of turns in the coil.

Flux linkage

$$(\Psi) = N\phi$$

$$e = \frac{d\Psi}{dt}$$

i.e.

$$\Psi \propto \phi \propto B \propto i$$

$$\Psi \propto i$$

$$\Psi = Li$$

$$e = \frac{d\Psi}{dt}$$

$$e = L \frac{di}{dt}$$

$$\psi = N\phi$$

$$\psi = Li$$

So,

$$N\phi = Li$$

$$L = \frac{N\phi}{i}$$

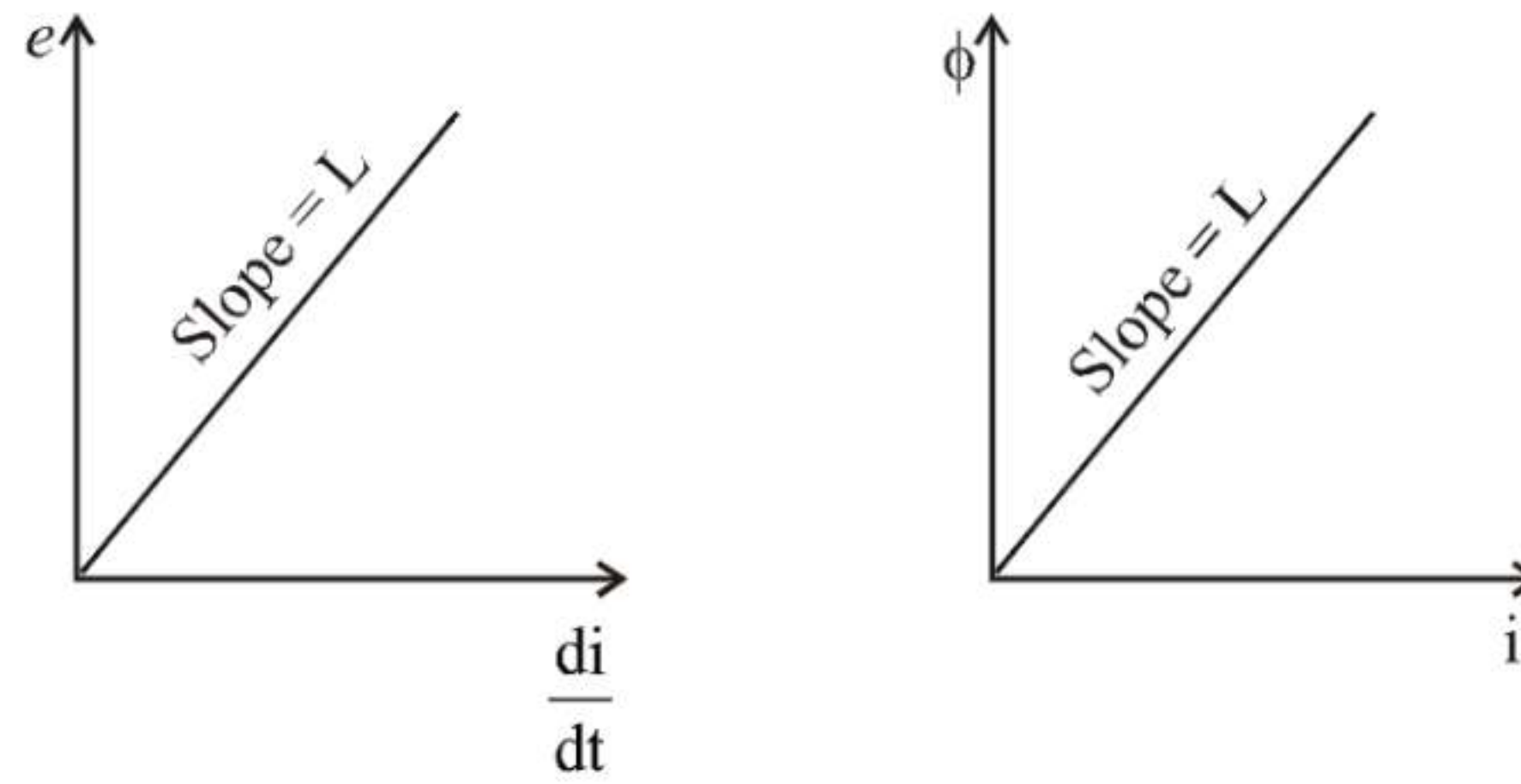

$$e = L \frac{di}{dt}$$

If current through inductor remains constant, the voltage drop will be zero. It means short circuited coil. This is the steady state condition.

If current changes within zero time ($dt = 0$). It will give infinite voltage drop across inductor which is not feasible practically. Thus inductor always oppose change in current abruptly.

- When inductance does not depend upon the current, inductor is called as linear inductor.

Example: Air core inductor.

- When inductance depend on the current, inductor is called as non-linear inductor.

Example: Iron core inductor

- Inductor store energy in the form of magnetic field (kinetic energy).

$$L = \frac{N\phi}{i}$$

Where,

$$\phi = \frac{\text{Magneto motive force (MMF)}}{\text{Reluctance(s)}}$$

$$\phi = \frac{NI}{l / A\mu_0\mu_r} = \frac{\mu_0\mu_r NIA}{l}$$

Where,

A = Cross sectional area of core

l = Length of core

$\mu_0 = 4\pi \times 10^{-7}$ H/m

μ_r = Relative permeability

Then,

$$L = \frac{\mu_0\mu_r N^2 A}{l} = \frac{N^2}{l / A\mu_0\mu_r}$$

$$L = \frac{N^2}{s}$$

$$L \propto N^2$$

Inductance of an inductor in directly proportional to square of number of turns.

Energy stored in inductor

Voltage across inductor is given by

$$V = L \frac{di}{dt}$$

and power

$$P = VI$$





$$P = Li \frac{di}{dt}$$

$$W = \int P dt = \int Li \frac{di}{dt} dt$$

$$= L \int i di$$

$$W = \frac{1}{2} Li^2$$

In ideal inductor, the average power dissipation is equal to zero because it does not have internal resistance.

(iii) Capacitor

It is a device used to store an electric charge consisting of one or more pairs of conductors separated by an insulator.

It is a passive electronic component that store energy in the form of an electrostatic field (potential energy).

It is indicated by (C) and unit is farad (F).

Stored charge is directly proportional to applied voltage.

i.e.,

$$Q \propto V$$

$$Q = CV$$

$$C = \frac{Q}{V} = \frac{\text{Coulomb}}{\text{Volt}} = \text{Farad}$$

Since the unit of capacitance is very large so we measure capacitance in smaller unit like μF .

Formulae related to capacitor

$$I = C \frac{dV}{dt}$$

$$V = \frac{1}{C} \int_{-\infty}^t I dt$$

$$P = CV \frac{dV}{dt}$$

Energy stored in capacitor

$$W = \int P dt = \int VC \frac{dV}{dt} dt = C \int V dV$$

Log on to : www.engineersacademy.org

$$W = \frac{1}{2} CV^2$$

- In ideal capacitor, power dissipation is equal to zero, because it does not have internal resistance.
- When capacitance of capacitor does not depend on the voltage, it is called as linear capacitor.
- When capacitance of capacitor depends on the voltage, it is called as non-linear capacitor.

Example: Varactor diode.

- If voltage is under steady state like DC voltage.

i.e.,

$$dV = 0$$

$$i = C \frac{dV}{dt} = 0$$

$$i = 0$$

It means, there is no current in the circuit.



- Capacitor does not allow sudden change of voltage because current through capacitor will be infinite which is practically not possible.

$$i = C \frac{dV}{dt}$$

if $dt = 0, i = \infty$

- Ideal capacitor has infinite value of time constant and for practical capacitor, the value of time constant is less

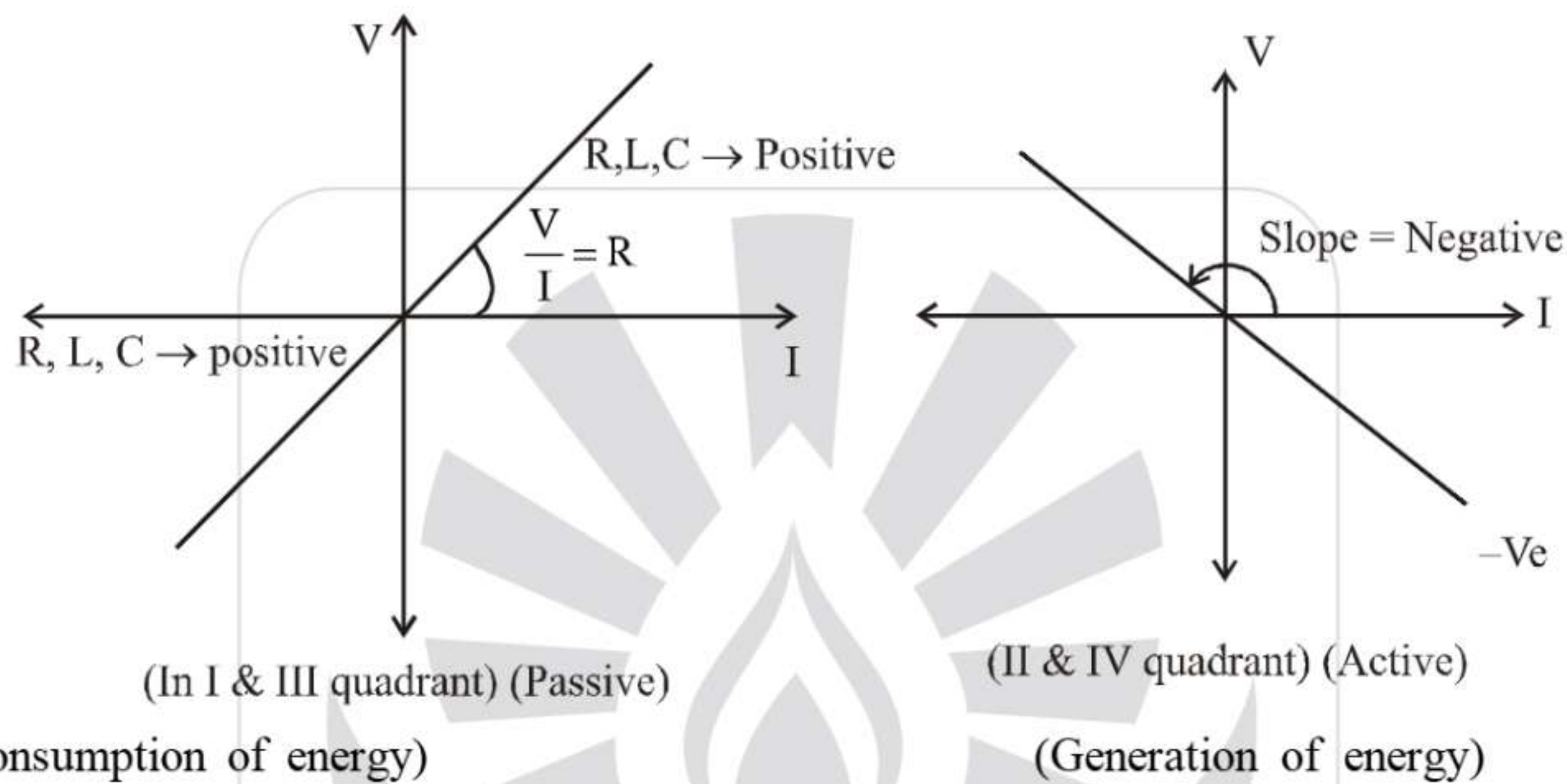
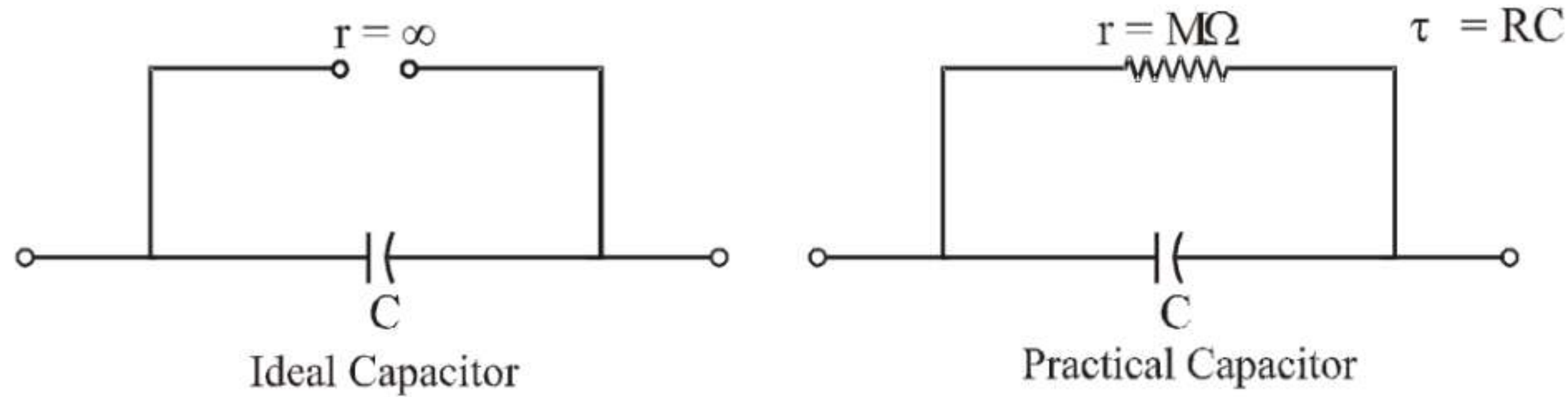

1.2.2 BIDIRECTIONAL AND UNIDIRECTIONAL ELEMENT

When element have properties which does not depend on the flow of direction of current, is called as bidirectional element.

Example: Inductance, Resistor, Capacitor.

When element have properties that they depend on the flow of direction of current is called as unidirectional element.

Example: Diode.

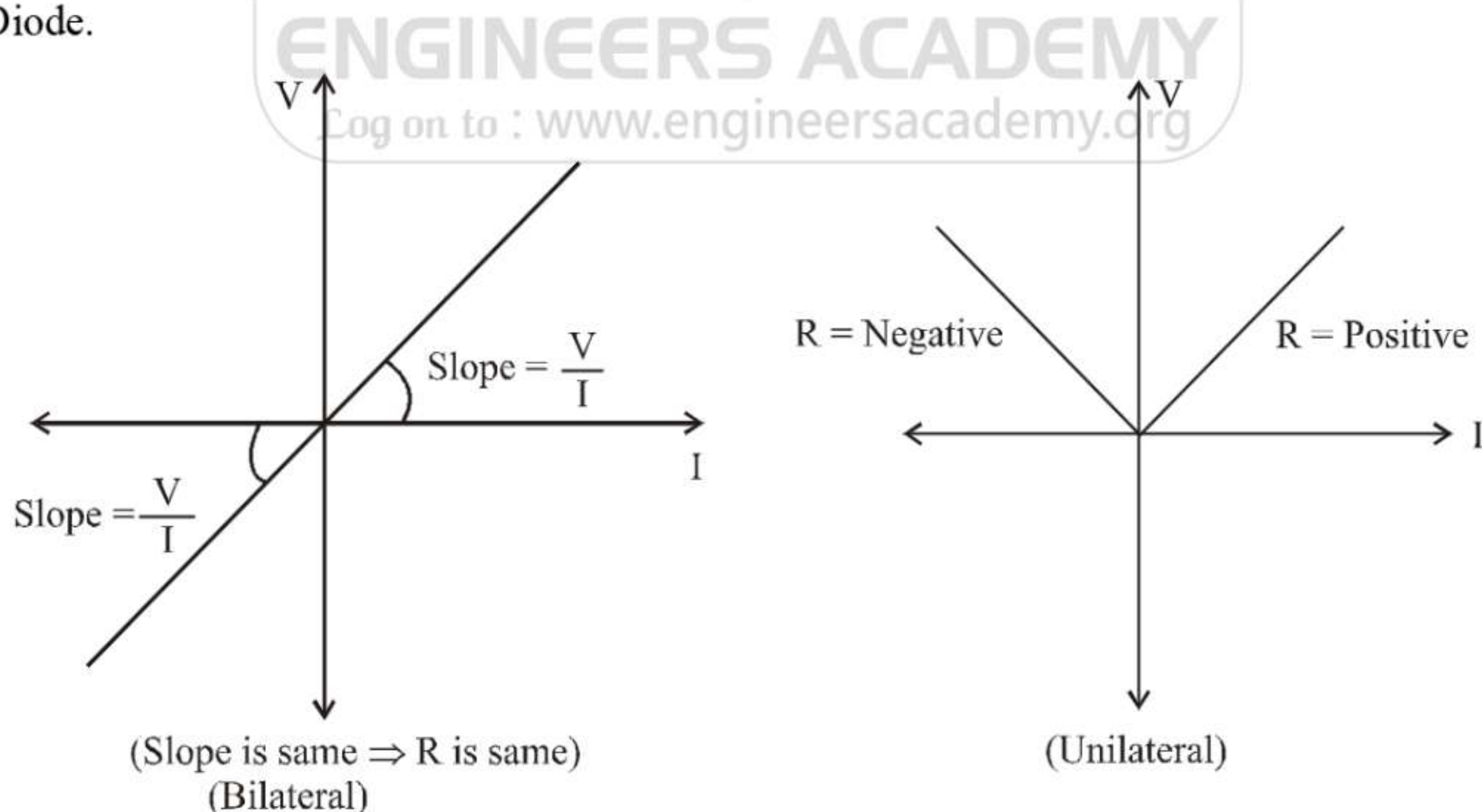



1.2.3 LINEAR AND NON-LINEAR ELEMENT

When element follow ohm's law then it is known as linear element.

Note: (a) Network is valid if frequency < 1 MHz.
 (b) Electromagnetic theory is valid for high frequency (about 1 MHz)

$$\left. \begin{matrix} \sigma = 0 & R = \infty \\ \sigma = \infty & R = 0 \end{matrix} \right\} \text{No Network analysis.}$$

Active : No need of external source.

Passive : Requires external source of energy.

$R, L, C \geq 0$ Passive element (consuming energy)

$R, L, C < 0$ Active element (negative)

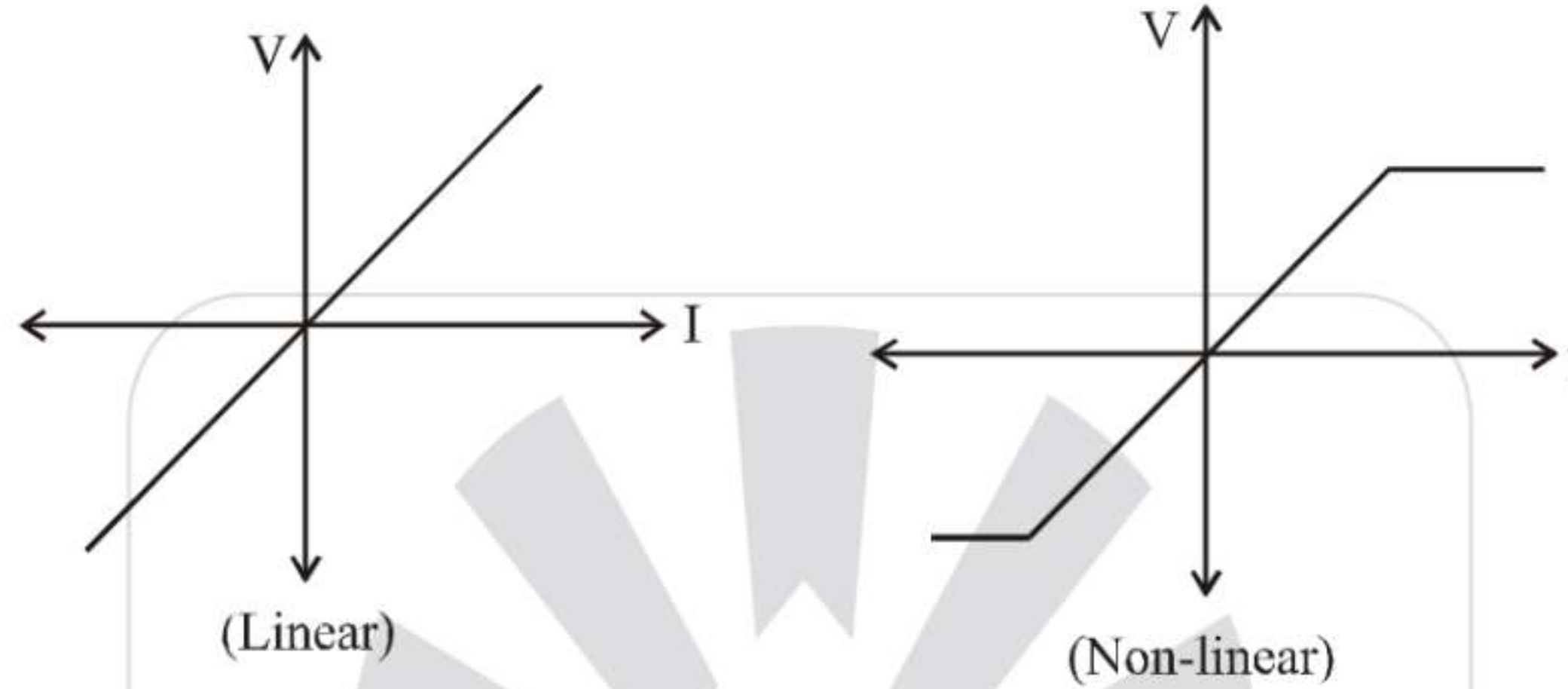

1.2.4 LUMPED AND DISTRIBUTED ELEMENT

Physically separate elements such as resistors, capacitors and diodes are lumped materials. On the other hand network elements which are inseparable for analytical purposes are called distributed elements.

1.2.5 TIME VARIANT AND TIME INVARIANT

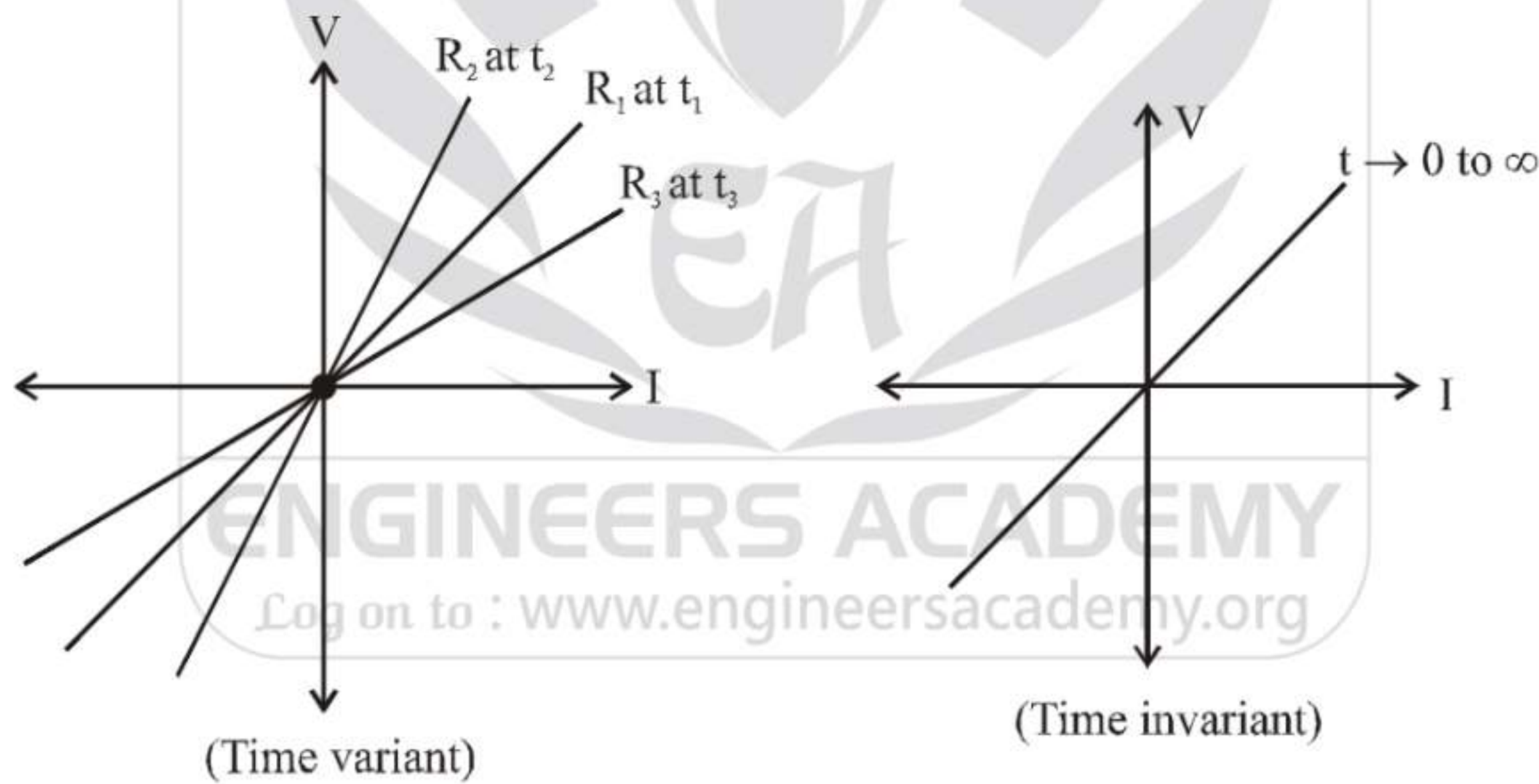

1.3 INDEPENDENT SOURCE

1.3.1 VOLTAGE SOURCE

(i) **Ideal Voltage Source**

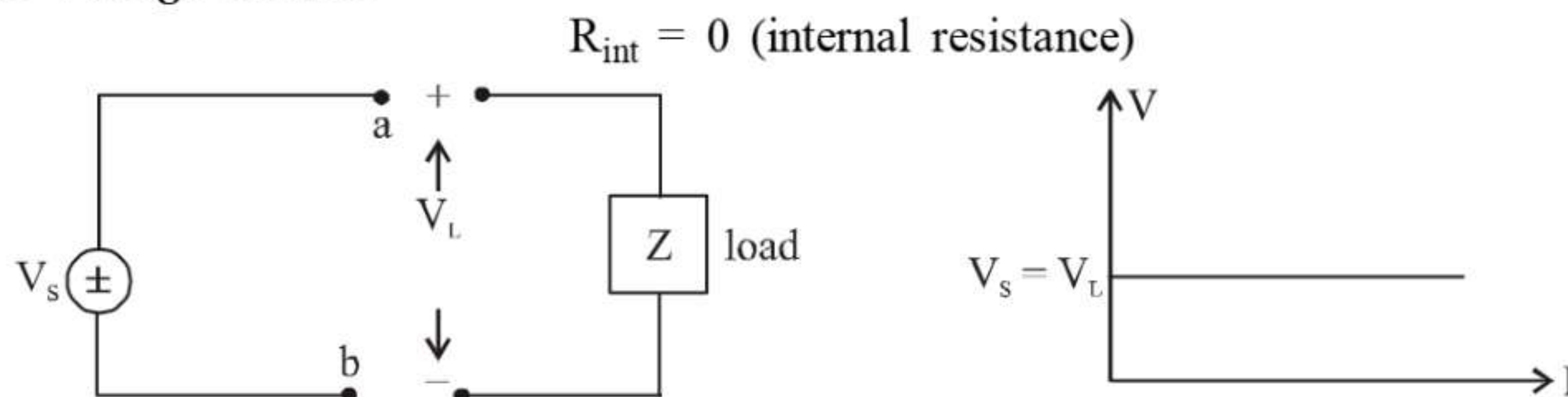



- We can't predict current across ideal voltage source, it can be determine only by other parameter current can be any value (0 to ∞)
- Ohm's law is not applicable here.
- For an ideal voltage source, the terminal voltage is independent of terminal current.
- V-I characteristics of ideal voltage source is non-linear.
- Inherently all the sources are non-linear in nature, since V & I are non-linear, but the non-linearity of independent sources are ignored in network theory, otherwise sources are active and unilateral element.

(ii) **Practical Voltage Source**

$$R_{int} \neq 0$$

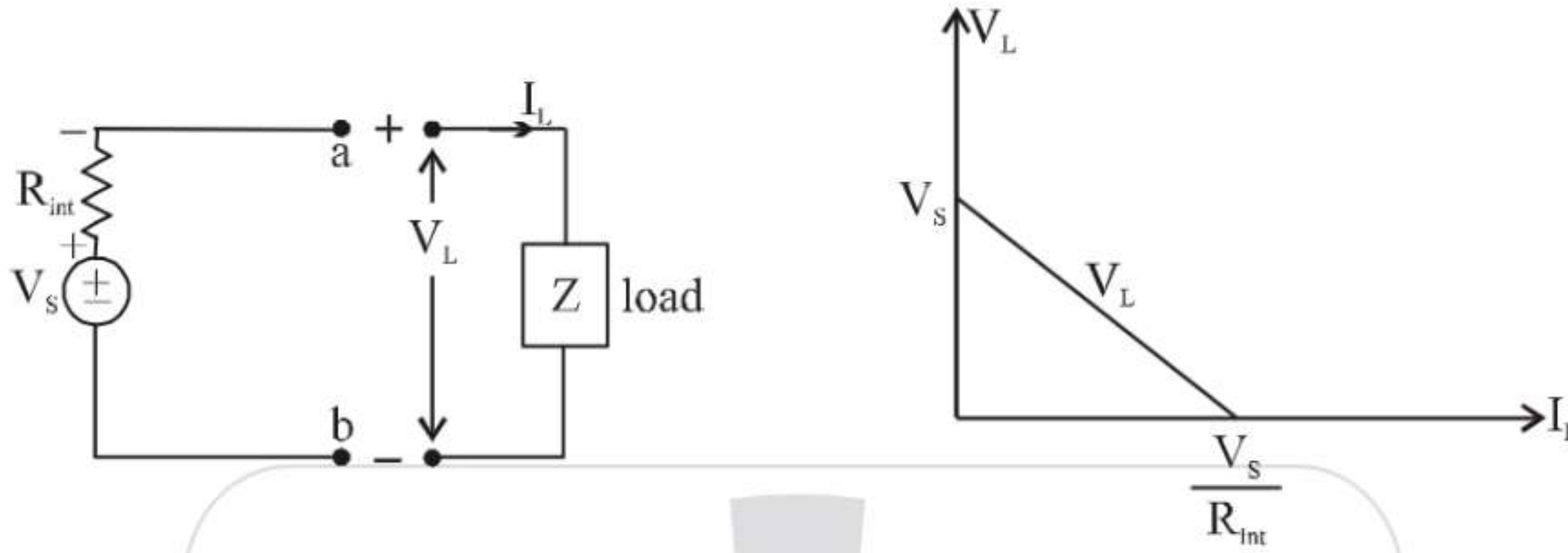

$$-V_s + IR_{int} + V_L = 0$$

$$V_L = V_s - IR_{int}$$

(Current can be predicted)

1.3.2 CURRENT SOURCE

(i) **Ideal Current Source**

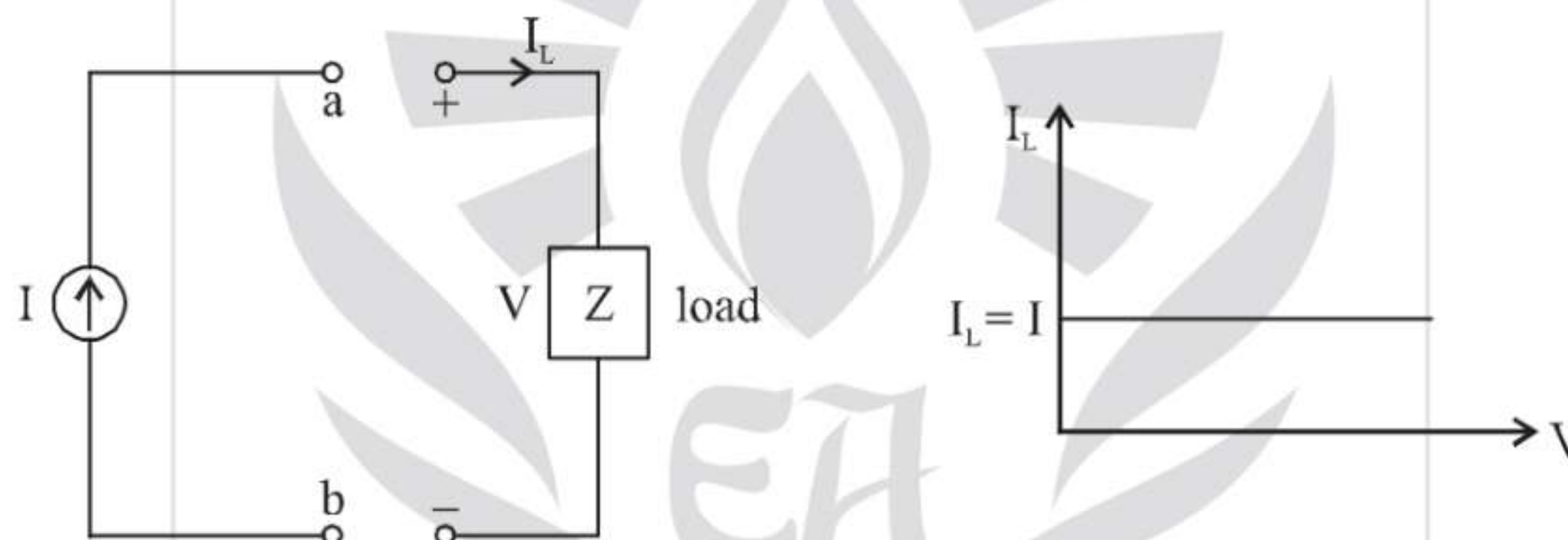

- For ideal current source, current is constant and independent of voltage and load.
- For ideal current source, the terminal current source is independent of terminal voltage.

(ii) **Practical Current Source**

$$R(\text{internal}) = \infty.$$

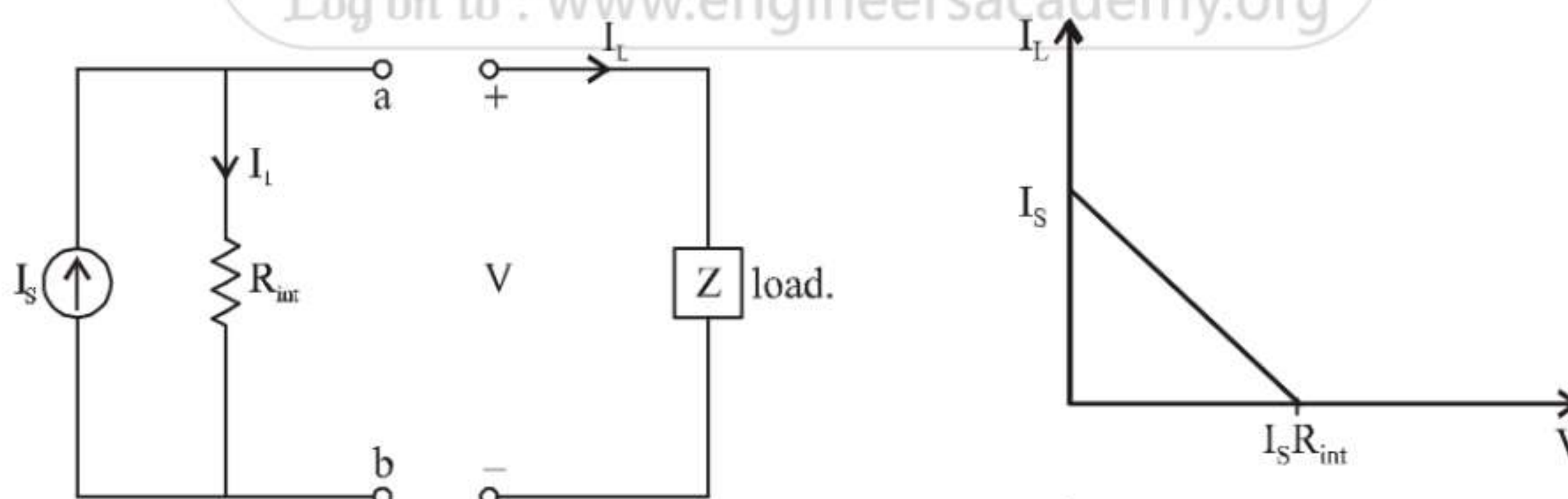

$$I_s - I_1 - I_L = 0$$

$$\Rightarrow I_L = I_s - I_1$$

$$\Rightarrow I_L = I_s - \frac{V}{R_{int}}$$

1.4 DEPENDENT SOURCE

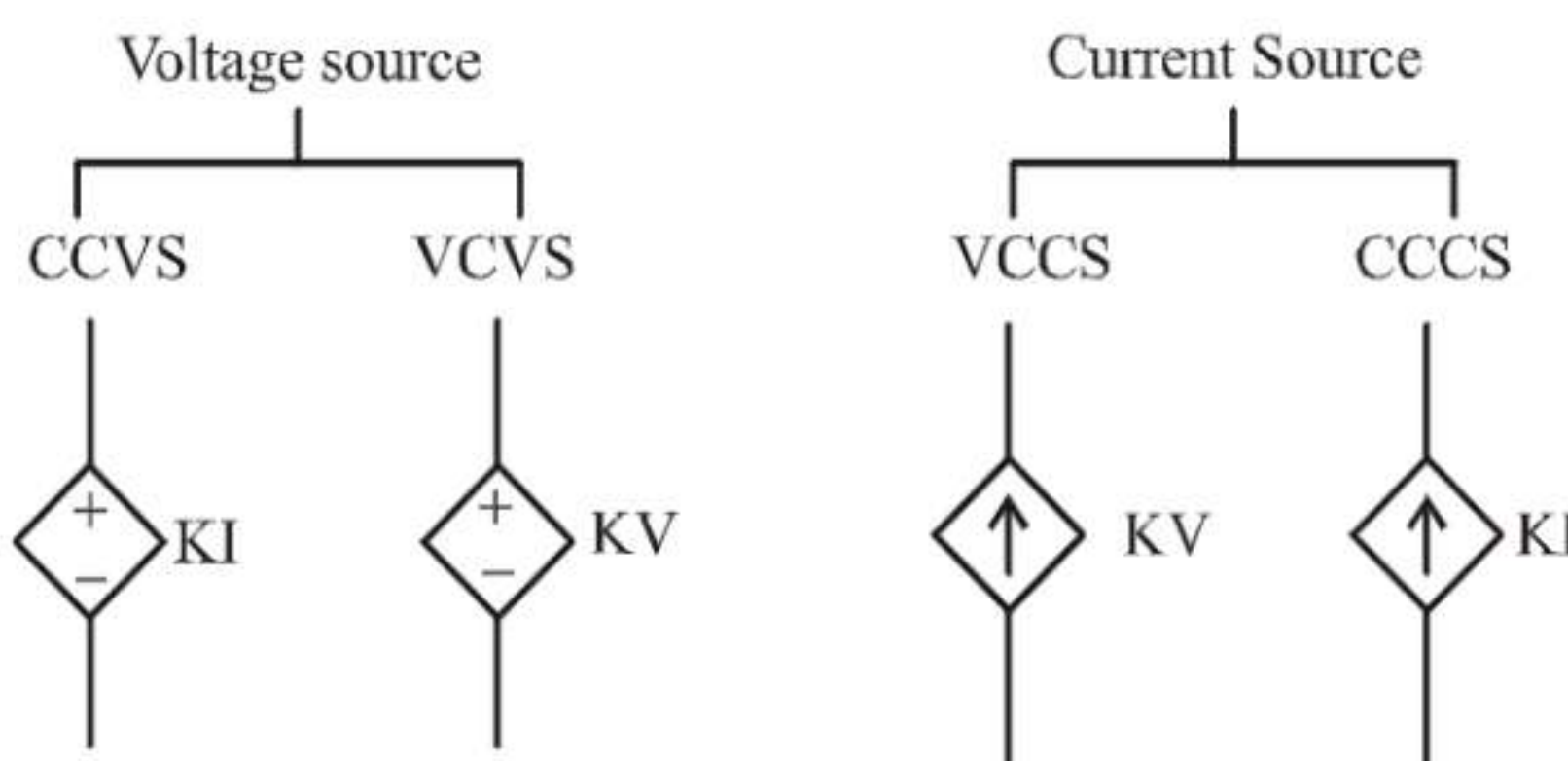

Inherently the controlled sources are also non-linear in nature, since the voltage and current relationship is non-linear. But the linearity of the controlled source is defined w.r.t. controlling independent variable. If they are linear, then the sources are said to be linear, otherwise non-linear.

The presence of controlled source in a Network makes it an active Network.

1.5 KIRCHHOFF'S LAWS

There are simple relationship between currents and voltages of different branches of an electric circuit. These relationships are determined by some basic laws that are known as kirchhoff laws, There are two laws

- (i) Current law
- (ii) Voltage law

1.5.1 KIRCHHOFF'S CURRENT LAW (KCL)

- It is based on law of conservation of charge.
- It states that, algebraic sum of current meet at a point is equal to zero.
- All incoming current is positive and outgoing current is negative

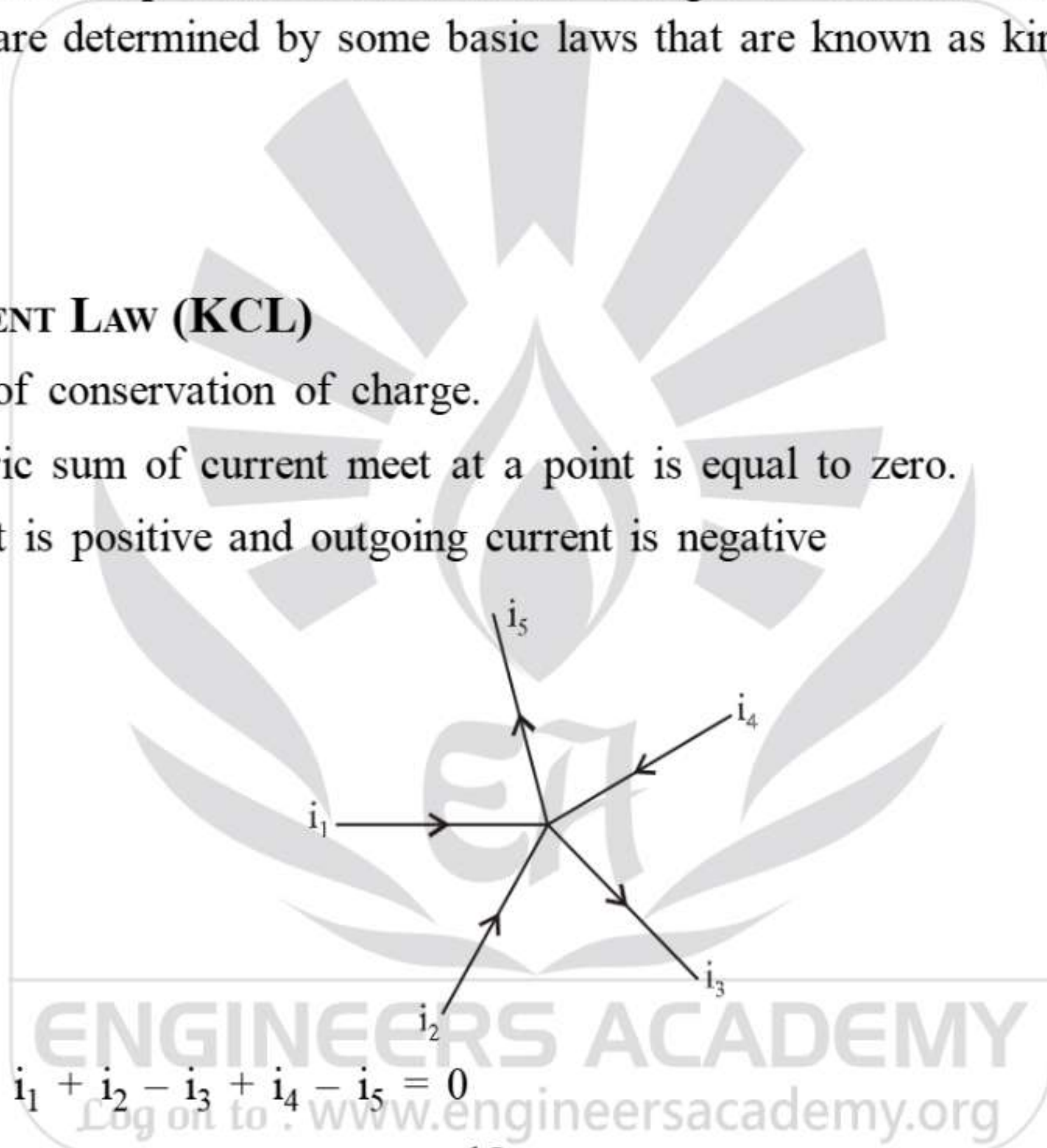

...(i)

We know that
$$i = \frac{dQ}{dt}$$

$$\frac{dQ_1}{dt} + \frac{dQ_2}{dt} - \frac{dQ_3}{dt} + \frac{dQ_4}{dt} - \frac{dQ_5}{dt} = 0$$

$$Q_1 + Q_2 - Q_3 + Q_4 - Q_5 = 0$$

...(ii)

KCL is based on law of conservation of charge.

as,
$$Q = ne$$

$$\therefore n_1e^- + n_2e^- - n_3e^- + n_4e^- - n_5e^- = 0$$

$$\Rightarrow n_1 + n_2 - n_3 + n_4 - n_5 = 0$$

...(iii)

where n is number of electron entering or leaving.

Note: KCL is valid only for lumped electrical circuit not for distributed circuit.

KCL doesn't depend on the type of elements used in the circuit. So KCL is valid for linear, non-linear, active, passive, time-variant & time invariant and other circuit element.

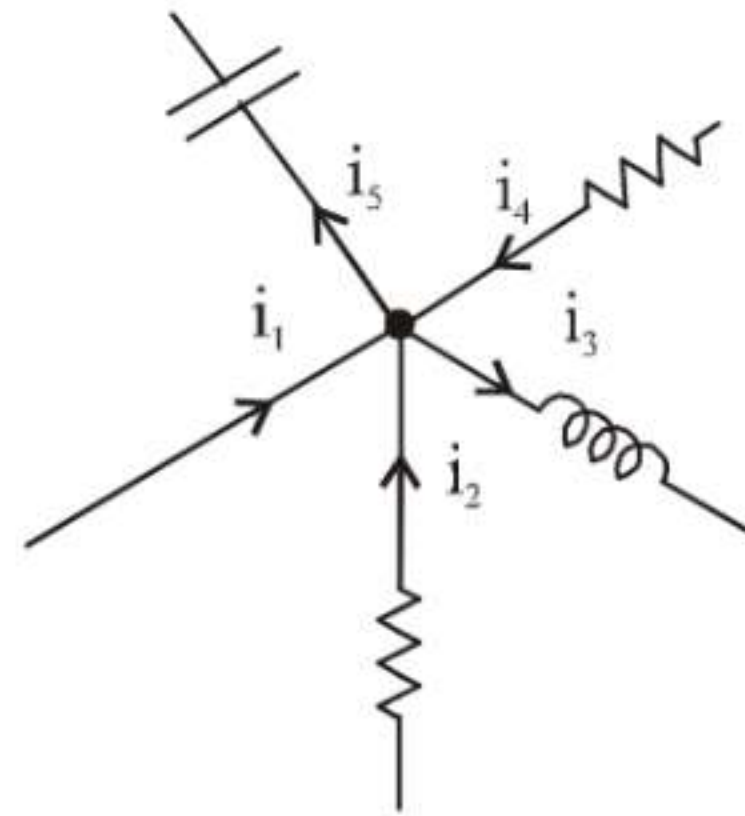

$$i_1 + i_2 - i_3 + i_4 - i_5 = 0$$

1.5.2 KIRCHOFF'S VOLTAGE LAW (KVL)

- It is based on law of conservation of energy.
- It states that the algebraic sum of the voltage in a closed loop is equal to zero.

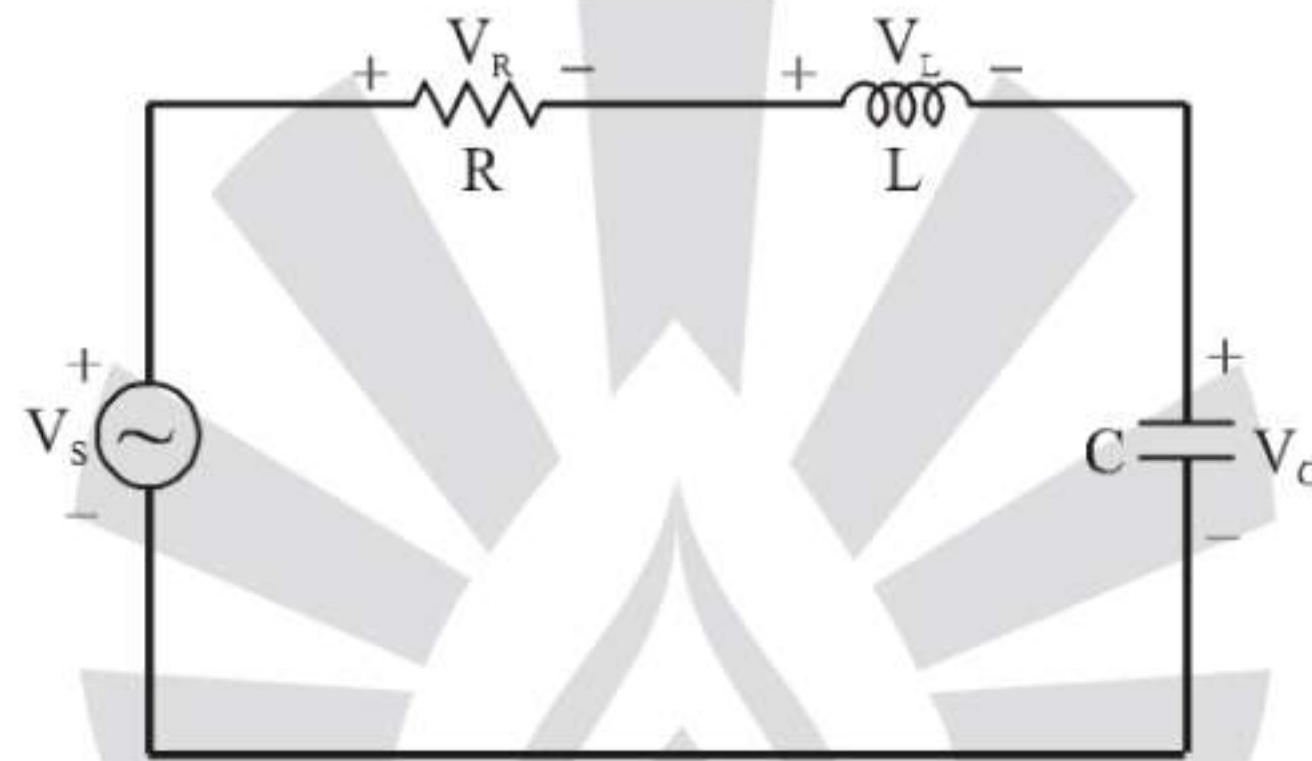

$$-V_S + V_R + V_L + V_C = 0$$

$$\therefore V = \frac{W}{Q} \text{ and } Q \text{ is same in series.}$$

$$\text{So, } -\frac{W_S}{Q} + \frac{W_R}{Q} + \frac{W_L}{Q} + \frac{W_C}{Q} = 0$$

$$-W_S + W_R + W_L + W_C = 0$$

- KVL is based on law of conservation of energy.
- KVL is valid for lumped electrical circuit not for distributed circuit.
- KVL is independent of nature of circuit elements.

KVL + Ohm's law → Mesh analysis

KCL + Ohm's law → Nodal analysis

1.6 OHM'S LAW

$$V = IR$$

$$J = \sigma E$$

$$V_C = \frac{1}{C} \int_0^t dt$$

$$I_C = C \frac{dV_C}{dt}$$

$$I_L = \frac{1}{L} \int_{-\infty}^t V_L dt$$

$$V_L = L \frac{di}{dt}$$

- Ohm's law is valid only at constant temperature.
- Ohm's law is not valid for ideal source. (due to non-linearity).
- But in Nodal and mesh, ideal sources can be used and their non-linearities can be neglected.

1.7 EQUIVALENT CIRCUIT

1.7.1 SERIES

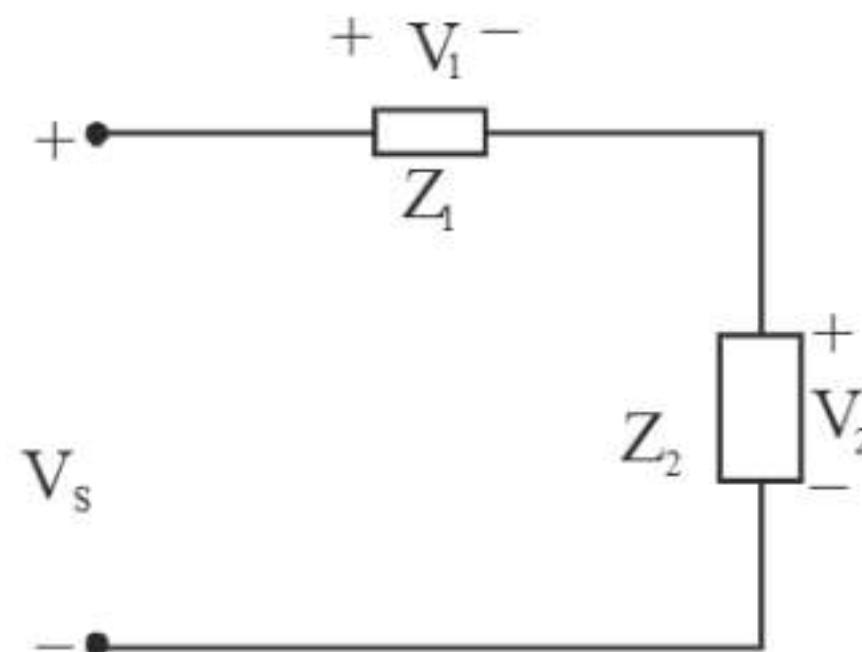

$$Z_{eq} = Z_1 + Z_2$$

Resistance

$$Z = R$$

$$R_{eq} = R_1 + R_2$$

(Series)

Inductance

$$Z = j\omega L$$

$$j\omega L_{eq} = j\omega L_1 + j\omega L_2$$

$$L_{eq} = L_1 + L_2$$

(Series)

Capacitance

$$Z = \frac{1}{j\omega C}$$

$$\frac{1}{j\omega C_{eq}} = \frac{1}{j\omega C_1} + \frac{1}{j\omega C_2}$$

$$\frac{1}{C_{eq}} = \frac{1}{C_1} + \frac{1}{C_2}$$

$$C_{eq} = \frac{C_1 C_2}{C_1 + C_2}$$

(Series)

Voltage Division Rule

$$Z_{eq} = Z_1 + Z_2$$

$$I = \frac{V_s}{Z_{eq}} = \frac{V_s}{Z_1 + Z_2}$$

$$V_1 = IZ_1$$

$$V_2 = IZ_2$$

$$V_1 = \frac{Z_1}{Z_1 + Z_2} V_s$$

$$V_2 = \frac{Z_2}{Z_1 + Z_2} V_s$$



Resistance

$$V_1 = \frac{R_1}{R_1 + R_2} V_S$$

$$V_2 = \frac{R_2}{R_1 + R_2} V_S$$

Inductance

$$V_1 = \frac{L_1}{L_1 + L_2} V_S$$

$$V_2 = \frac{L_2}{L_1 + L_2} V_S$$

Capacitance

$$V_1 = \frac{C_2}{C_1 + C_2} V_S$$

$$V_2 = \frac{C_1}{C_1 + C_2} V_S$$

1.7.2 PARALLEL

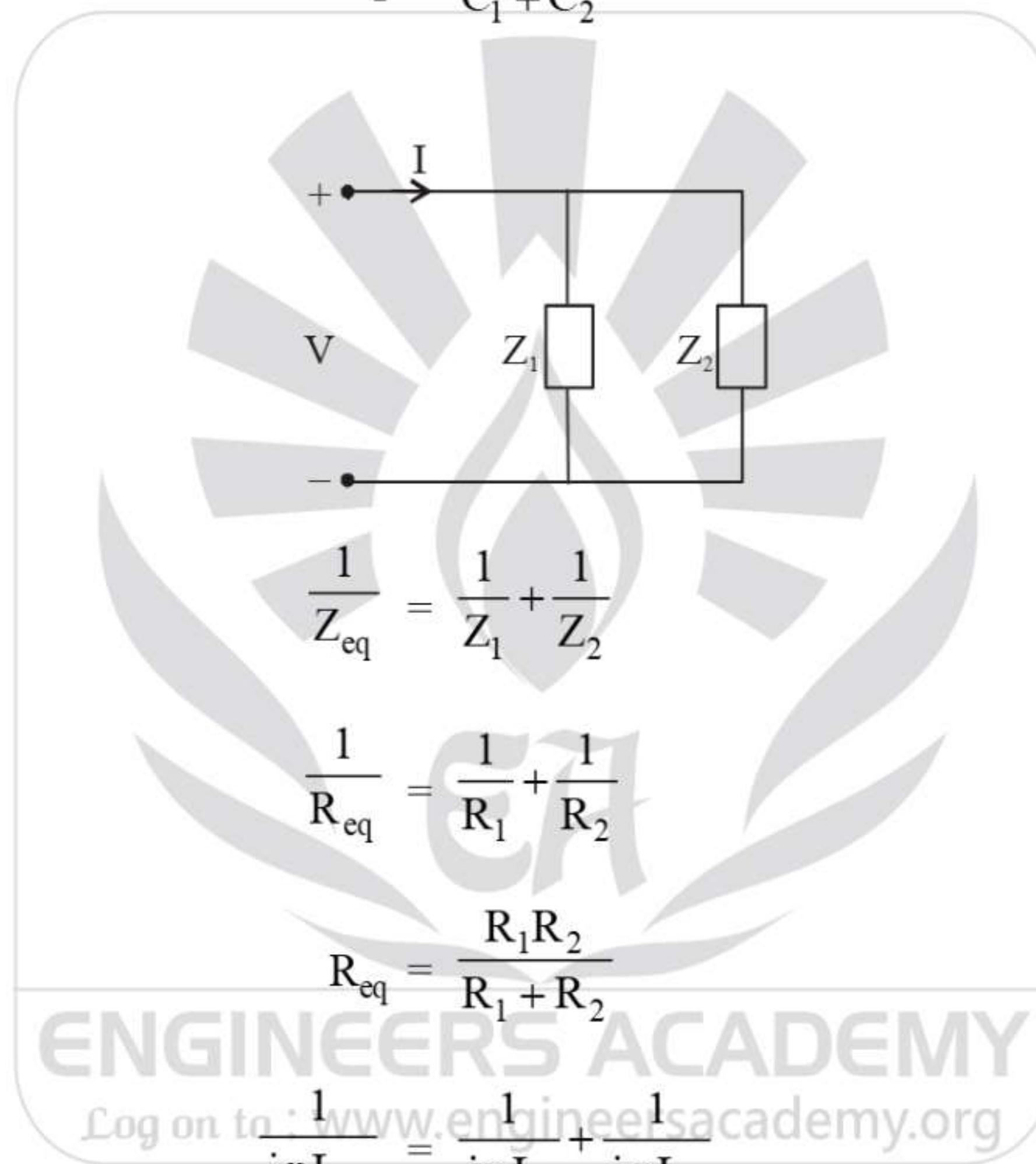

Resistance

$$\frac{1}{Z_{eq}} = \frac{1}{Z_1} + \frac{1}{Z_2}$$

$$\frac{1}{R_{eq}} = \frac{1}{R_1} + \frac{1}{R_2}$$

⇒

$$R_{eq} = \frac{R_1 R_2}{R_1 + R_2}$$

Inductance

$$\frac{1}{j\omega L_{eq}} = \frac{1}{j\omega L_1} + \frac{1}{j\omega L_2}$$

⇒

$$L_{eq} = \frac{L_1 L_2}{L_1 + L_2}$$

Capacitance

$$j\omega C_{eq} = j\omega C_1 + j\omega C_2$$

⇒

$$C_{eq} = C_1 + C_2$$

Current Division Rule

$$V = I Z_{eq}$$

$$I_1 = \frac{V}{Z_1} = \frac{Z_1 Z_2}{Z_1 (Z_1 + Z_2)} I = \frac{Z_2}{(Z_1 + Z_2)} I$$



$$I_2 = \frac{V}{Z_2} = \frac{Z_1}{Z_1 + Z_2} I$$

Resistance

$$I_1 = \frac{Z_2}{Z_1 + Z_2} I$$

$$I_2 = \frac{Z_1}{Z_1 + Z_2} I$$

Inductance

$$I_1 = \frac{L_2}{L_1 + L_2} I$$

$$I_2 = \frac{L_1}{L_1 + L_2} I$$

Capacitance

$$I_1 = \frac{C_1}{C_1 + C_2} I$$

$$I_2 = \frac{C_2}{C_1 + C_2} I$$

1.8 DELTA AND STAR CONNECTION

When elements are connected neither in series nor in parallel. To reduce this kind of network star-delta transform is used.

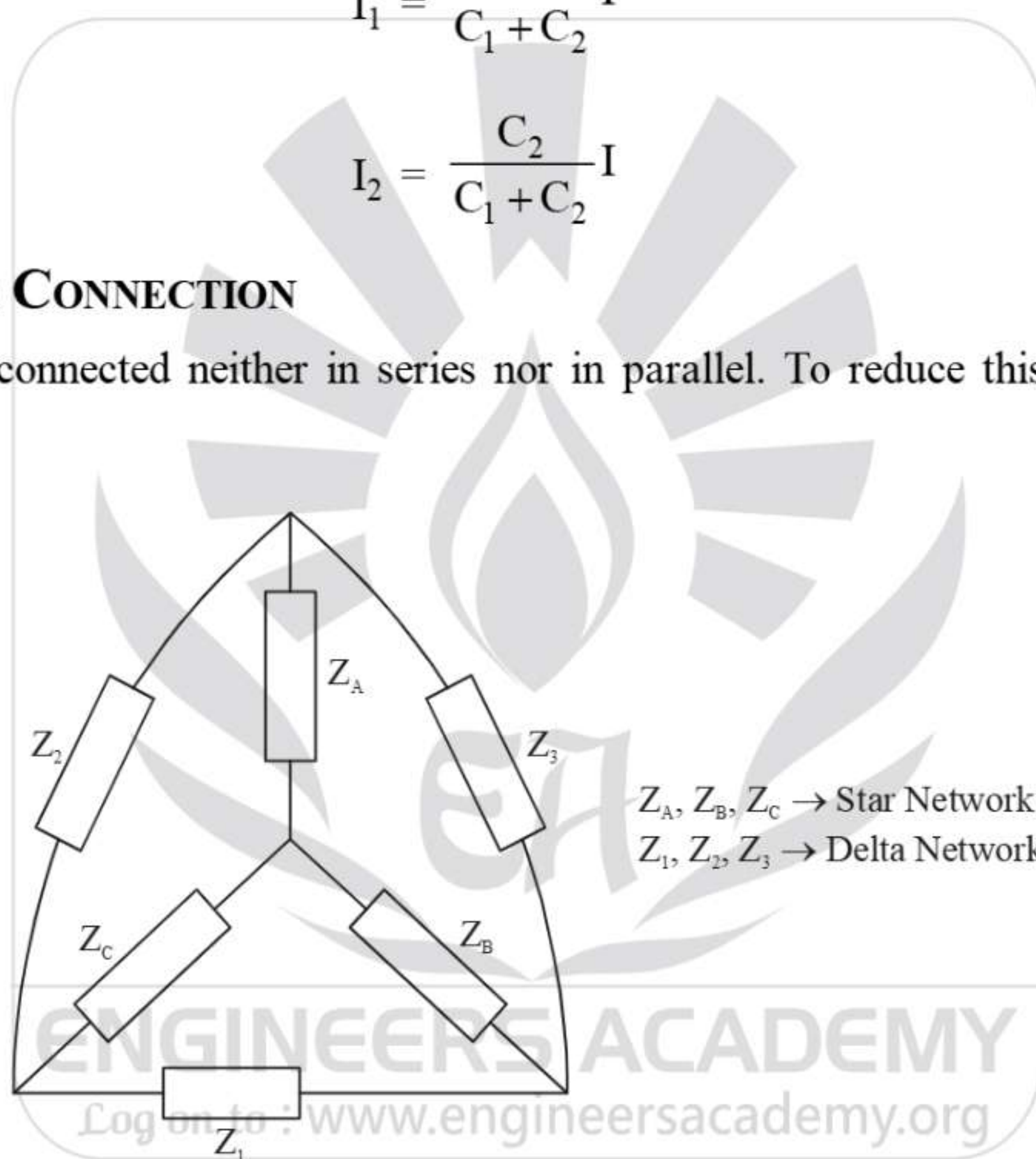

Delta to Star Conversion	Star to Delta Conversion
<ul style="list-style-type: none"> $Z_A = \frac{Z_2 Z_3}{Z_1 + Z_2 + Z_3}$ $Z_B = \frac{Z_1 Z_3}{Z_1 + Z_2 + Z_3}$ $Z_C = \frac{Z_1 Z_2}{Z_1 + Z_2 + Z_3}$ 	<ul style="list-style-type: none"> $Z_1 = \frac{Z_A Z_B + Z_B Z_C + Z_C Z_A}{Z_A}$ $Z_2 = \frac{Z_A Z_B + Z_B Z_C + Z_C Z_A}{Z_B}$ $Z_3 = \frac{Z_A Z_B + Z_B Z_C + Z_C Z_A}{Z_C}$

Star connection is also known as T-connection.



Note : If Delta $\Rightarrow 3\Omega$ (each resistance)

then Star $\Rightarrow 1\Omega$ (each resistance)

for R & L; $\Delta = 3 \times \text{Star}$

for C; $\Delta = \frac{1}{3} \times \text{Star}$

Star to Delta, impedance $\uparrow \Rightarrow C \downarrow \Rightarrow R \& L \uparrow$

Example 1: The current flowing through the capacitor is shown in figure, then determine the charge stored by the capacitor upto the 7 msec?

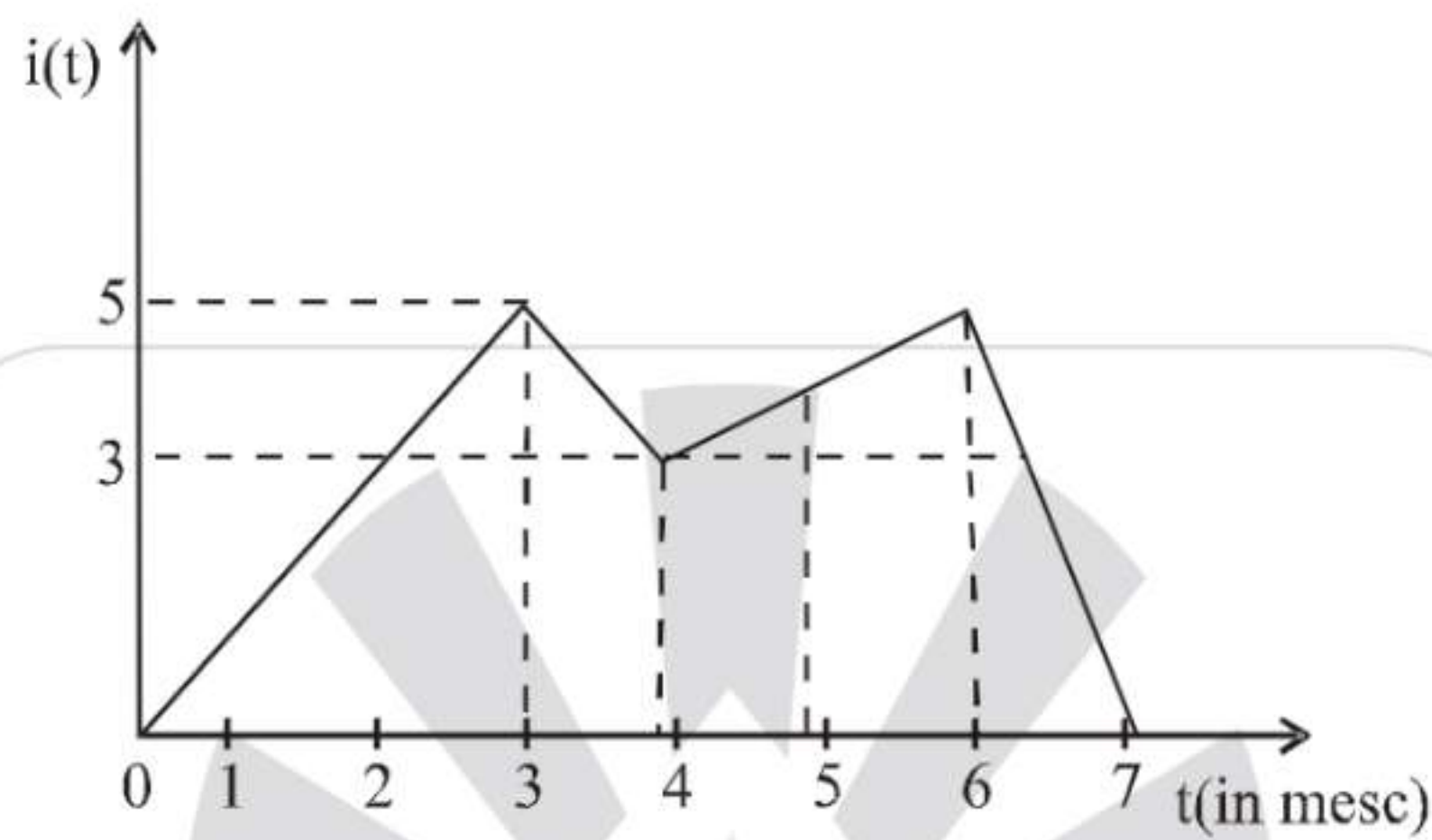

Solution : The area of under curve $i(t)$ and t gives stored charge

$$\begin{aligned}
 Q &= \int i(t) dt \\
 &= \int_0^3 i(t) dt + \int_3^4 i(t) dt + \int_4^6 i(t) dt + \int_6^7 i(t) dt \\
 &= \left(\frac{1}{2} \times 3 \times 5 \right) + \frac{1}{2} \times 1 \times (3 + 5) + \frac{1}{2} \times 2 \times (3 + 5) + \frac{1}{2} \times 1 \times 5 \\
 &= \frac{15}{2} + 4 + 8 + \frac{5}{2} = 22 \text{ milli coulomb}
 \end{aligned}$$

Example 2: A fully charged mobile phone with 12 V is good for 10 min talk time. Assume that during the talk time the battery delivers a constant current of 2 Amp and its voltage drops linearly from 12 Volts to 10 Volts as shown in the figure.

How much energy does the battery deliver during talk time.

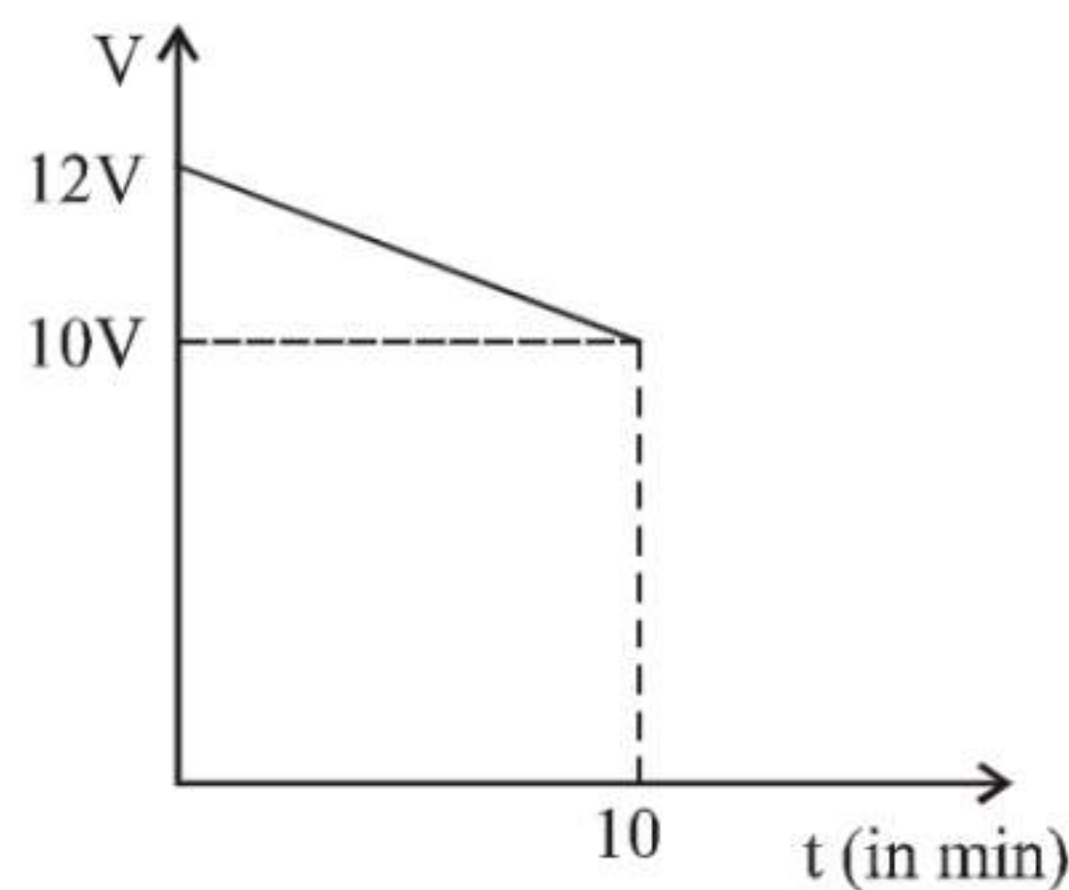

Solution :

$$E = \int P dt = \int V I dt = 2 \int_0^{t_1} V dt$$

$$t_1 = 10 \text{ min} = 600 \text{ sec}$$

$$E = 2 \int_0^{600} V dt = 2 \times \left[600 \left(\frac{10+12}{2} \right) \right] = 13.2 \text{ kJ}$$

Example 3 : The current is flowing through 10Ω resistor. Find the average power dissipated by the resistor.

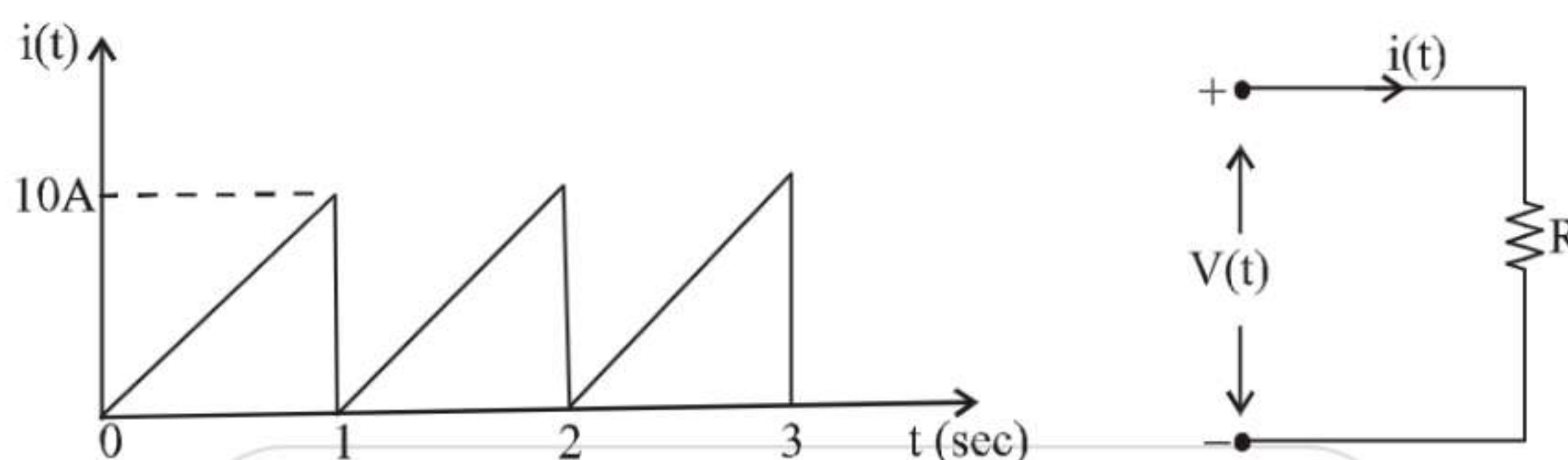

Solution :

$$P = I^2 R$$

$$P_{avg} = I_{rms}^2 R$$

$$I_{rms}^2 = \frac{1}{T} \int_0^T i^2(t) dt$$

$$m = \frac{10-0}{1-0} = 10$$

So,

$$y = mx + C$$

$$i(t) = 10t$$

So,

$$I_{rms}^2 = \frac{1}{T} \int_0^1 100t^2 dt = 100 \left(\frac{t^3}{3} \right)_0^1 = \frac{100}{3}$$

$$P_{avg} = I_{rms}^2 R = \frac{100}{3} \times 10 = 333.33 \text{ W}$$

Example 4 : Find the average power dissipated by 1Ω resistor.

